

**MONSTER**  
**PERFORMANCE CAR™**  
**FACTORY•LINK™**  
with  SoundGate® technology

**MONSTER®**  
**iCruze®**  
for iPod®

**ICRUZE INTERFACE CABLE**  
**MPC FX IC-FD6**

**INSTALLATION & USER GUIDE**

## IMPORTANT NOTE:

**The installation of iCruze will disconnect and cease the normal operation and function of the factory-installed CD changer, satellite radio, and is designed for use on vehicles without factory DVD entertainment systems.**

**This cable is designed to work with Monster Factory•Linx Interface Module IM-FD1. Make certain you have purchased this Interface Module or your iCruze installation will not function. Read these instructions and the Interface Module instructions before beginning.**

The Monster® Factory•Linx™ Interface Cable(s) and/or Module(s) enclosed are custom designed for your particular vehicle. Because every vehicle is different, unique adaptors are required to make your iCruze® installation and operation function exactly as it was designed. Each is designed and tested to fit correctly and made from the top quality materials for trouble-free operation.

## A NOTE FROM THE HEAD MONSTER

Thank you for purchasing the Monster Factory•Linx™ iCruze®—one of the most exciting products Monster has ever offered. Monster worked closely with the engineers at Apple to design iCruze to give you the most reliable, most complete control of your iPod® through your factory car stereo. iCruze also gives you a direct connection for crystal clear sound quality. And it charges your iPod the entire time you're driving, so when you leave the car your iPod is charged up and ready to go. You'll soon be wondering how you ever got along without your iPod and iCruze in your car.

When you put music, driving and iPod together, Life is Good.

Monsterously,



Noel Lee,

The Head Monster



**Noel Lee,**  
*The Head Monster*

## LOSS OF CERTAIN EXISTING FUNCTIONS

- ⚠ Use and installation of iCruze requires disconnection and loss of use of any existing factory installed non-integrated CD-changer (i.e. trunk, center console, under seat).
- ⚠ iCruze is not compatible with some vehicles that have existing, factory installed integrated CD changers. Typically this is an in-dash CD changer. Call your dealer and ask if your factory stereo has a CD or CD changer port/option on the rear of the stereo. If yes, then it is iCruze compatible.
- ⚠ Existing factory installed vehicle features, such as Satellite Radio, DVD entertainment systems, navigation systems and video cameras may be impacted by or cease to function with use and installation of iCruze, if these components were connected to the CD changer port. Check the iCruze in-store selection guide, visit [iPodiCruze.com](http://iPodiCruze.com), or call customer service at 1-415-840-2000 (9am–5pm Monday through Friday PT) for more details.

## INSTALLATION SAFETY PRECAUTIONS & WARNINGS

- ⚠ Monster is not responsible for any damage to your vehicle while installing iCruze. The wiring and installation of the iCruze requires technical skill. Monster recommends iCruze installation by a MECP certified professional car audio technician. If you choose to install yourself, be aware that specialized car stereo removal tools may be needed and can be found available for purchase on our website [iPodiCruze.com](http://iPodiCruze.com).
- ⚠ Make sure you have purchased the correct Monster Factory•Linx Interface Cable and/or Module. See the iCruze Factory•Linx in-store selection guide or visit [iPodiCruze.com](http://iPodiCruze.com) to ensure you have everything you need to install iCruze in your car. Double check

the iCruze in-store selection guide, visit [iPodiCruze.com](http://iPodiCruze.com), or call customer service at 1-415-840-2000 (9am–5pm Monday through Friday PT) for more details.

- ⚠ If your factory stereo is protected by an anti-theft code, have the code available so you can use your stereo once re-connected. Consult your car owner's manual or contact your local car dealer for more information.
- ⚠ Before installing iCruze, remove the cable from the negative battery terminal. Failure to do so may cause electrical shock and/or injury.
- ⚠ iCruze is designed to be installed in the dash near the car stereo. Installation elsewhere or in a dusty or moist area may cause problems or product failure.
- ⚠ Many connectors in your car may look the same. Do not force or alter the cable connectors to fit. Failure to do so may damage your vehicle's electronics, cause shock or fire.
- ⚠ While installing iCruze, make sure to avoid sharp edges which can damage wiring. Failure in doing so may cause iCruze to not work or result in a fire.
- ⚠ Do not attempt to take iCruze apart. The internal circuits are static sensitive and contain no user serviceable parts.

## IMPORTANT IPOD® FUNCTION NOTES & SAFETY

- ⚠ Monster is not responsible for any lost data on your iPod even during normal use of this product.

- ⚠ Monster is not responsible for damage caused to your iPod from misuse.
- ⚠ iCruze is compatible with iPod models with dock connector.
- ⚠ You should never leave or store your iPod in your vehicle for an extended amount of time. Failure to do so may damage your iPod from heat, cold and moisture extremes. See your iPod manual for acceptable temperature ranges.
- ⚠ For added safety and security while driving, Monster recommends placing the iPod in your glove box or other stow-away location such as a center console.
- ⚠ Your iPod must have certain firmware for proper iCruze compatibility. Minimum: version 1.2 for iPod Mini, version 1.0 for iPod Photo and version 2.2 for iPod. Visit [apple.com/support](http://apple.com/support) for more information.
- ⚠ When you unplug the iPod from the iCruze, you will notice that the iPod will display the iCruze logo for a short time which is normal. It will revert back to the usual screen shortly after this time period.
- ⚠ The functions and control of your iPod may differ depending on your radio. iCruze is limited by the available functions of your radio. I.E.- If your radio does not have a shuffle/random this feature will not be available.
- ⚠ iCruze utilizes playlists on your iPod to access music. Be sure to refer to your installation and user guide that came with iCruze for more details on how to optimize your playlist for use with the main iCruze unit.

## INCLUDED ITEMS

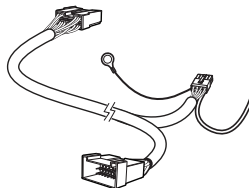

**(1) Monster Performance  
Car™ Factory•Linx™  
iCruze® Interface Cable  
Part # 151265**

## BEFORE YOU BEGIN

Because iCruze emulates a CD changer, if your vehicle currently has a CD changer installed, it will need to be unplugged for the iCruze to operate. Should you experience a problem, please call Customer Service at 1-415-840-2000 (9am–5pm Monday through Friday PT) to report it.

**IMPORTANT: Please completely read and review the installation guide that came with iCruze BEFORE you begin this installation for steps required prior to Interface Cable installation.**

## Installation Diagram/ Location Overview

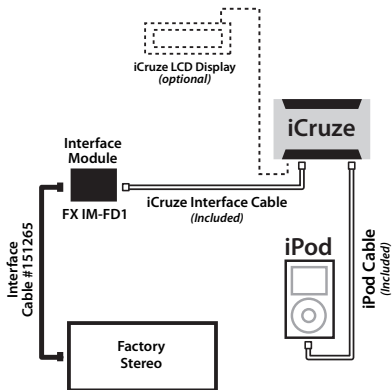

## INSTALLATION

Review the installation guide that came with iCruze for installation steps required prior to Interface Cable/Module installation.

### ⚠ WARNING:

**IF YOU HAVE NOT ALREADY DISCONNECTED THE NEGATIVE TERMINAL OF THE BATTERY, DO SO NOW. WE HIGHLY RECOMMEND CONSULTING YOUR OWNER'S MANUAL FOR VEHICLE SPECIFIC INSTRUCTIONS AND PRECAUTIONS REGARDING BATTERY CONNECTION/DISCONNECTION.**

### Step 1

Get the Interface Cable from the main iCruze package. The yellow wire needs to be connected to constant, unswitched power. This should be available from the car's stereo wire harness. Consult your car's factory service manual for the location of this wire. An MECF certified installation professional can also help.

To prevent cutting the car's wire harness, a T-Tap-type connector is recommended (be certain to use the proper size T-Tap to ensure a reliable connection).

## Step 2

### ⚠ WARNING:

**DO NOT ATTEMPT TO MAKE THIS CONNECTION UNLESS YOU HAVE THE EXPERIENCE AND KNOWLEDGE TO DO SO. INCORRECT CONNECTIONS MAY CAUSE MALFUNCTION OF CAR STEREO AND OTHER ELECTRICAL SYSTEM COMPONENTS. CONSULT AN MECP CERTIFIED INSTALLER IF YOU DO NOT HAVE THE TOOLS OR KNOWLEDGE TO MAKE THIS CONNECTION.**

Locate the wire you will use that has 12 volts constant power. Mark this wire or put your T-tap connector on it if you are using one, but do not connect the yellow wire from the iCruze Interface Cable to it yet. You will do this in Step 6.

## Step 3

The blue with white stripe wire goes between both ends of the cable. In the middle is a connector that comes apart. Pull the ends to disconnect them. The female end is not used and can be left alone.

## Step 4

Cut off the male 'bullet' end and connect this to 12 volt accessory power.

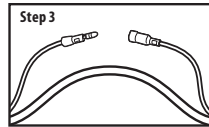
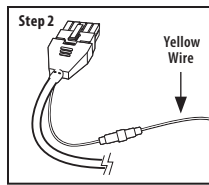

## Step 5

The Interface Cable from the iCruze box (steps 1-3) plugs into the "OEM Interface" port on iCruze with the rectangular or Molex® end, while the other round end goes directly into the Interface Module IM-FD1. Make sure to leave the yellow wire handy for Step 6.

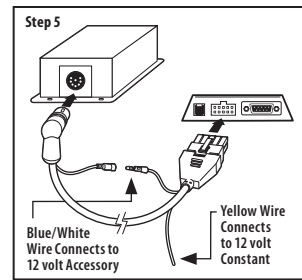

## Step 6

The Interface Cable in the Interface Cable IC-FD6 package looks like a "T" and has a pair of wires outside of the black jacketing. The yellow wire needs 12 volts constant power just like the yellow wire on the Interface Cable from the iCruze package. You may join the two yellow wires together and connect to the same 12 volt power source you found in Step 2.

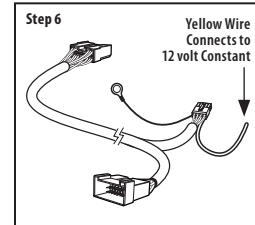

## Step 7

The black wires on the Interface Cable in the Interface Cable IC-FD6 package need to be connected to ground. Locate a suitable ground location and connect to ground.

## Step 8

The Interface Cable in the Interface Cable IC-FD6 package has three plastic connectors on it. The smallest male connector plugs into the other side of the Interface Module IM-FD1 (non-round plug side).

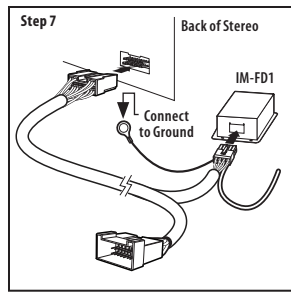

## Step 9

This leaves you with two plastic connectors on the Interface Cable in the Interface Cable IC-FD6 package that look nearly identical but one is male and the other female. The male connector plugs into the back of the factory stereo. However, you must first unplug the cable that is already there. Unplug this connector and insert it into the matching female connector on the Interface Cable IC-FD6. Take the remaining male connector on the Interface Cable IC-FD6 and plug it into the back of the stereo.

Though there is only one way to push the connectors in, don't force them. Double check that you have the correct Interface Cable for your installation by reviewing the in-store iCruze Factory-Linx Selection Guide, by visiting [iPodiCruze.com](http://iPodiCruze.com) or by calling iCruze Customer Support at 415-840-2000, Monday through Friday, 9am-5pm (PT).

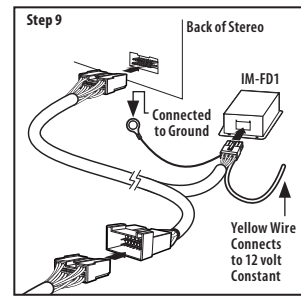

## INSTALLATION COMPLETE

Refer back to the installation guide that came with iCruze to complete your iCruze installation and for more details on using iCruze functions and features.

## OPERATION NOTES

All iCruze functions are supported for your car unless your factory stereo does not have FF, RW or REPEAT buttons. Support for 10 playlists (see Creating Playlists in the main iCruze manual). Switch to FM prior to turning off ignition. Connect and disconnect iPod while ignition is off. If you switch to iCruze and iPod indicates it is in pause (you do not hear any music), press and release Track UP or Track DN button to begin play. If you leave iPod connected after you turn off ignition, you may have to re-select it as a source when you turn ignition back on. If iPod display does not change to “iCruze” after turning ignition back on, disconnect and reconnect iPod.

## CUSTOMER SUPPORT

If you have questions, please try iPodiCruze.com for the latest updates to manuals, products and more. You can also call 1-415-840-2000 (9am–5pm Monday through Friday PT) for assistance.

## LIMITED WARRANTY FOR CONSUMERS

United States

Monster Cable Products, Inc. 455 Valley Drive, Brisbane, CA 94005 USA, 1-415-840-2000 (“Monster”) extends to You this Limited Warranty. Statutory or common law may provide You with additional rights or remedies, which shall not be affected by this Limited Warranty.

### DEFINITIONS

---

“**Adequate Use**” means use of the Product (i) within a home or dwelling, (ii) for private (as opposed to commercial) purposes, (iii) in conformance with all applicable local, state or federal law, code or regulations (including without limitation building and/or electrical codes), (iv) in accordance with manufacturer recommendations and/or instructions in the materials and documentation that accompany the Product, and (v) with proper electrical grounding.

“**Authorized Dealer**” means any distributor, reseller or retailer that (i) was duly authorized to do business in the jurisdiction where it sold the Product to You, (ii) was permitted to sell You the Product under the laws of the jurisdiction where You bought the Product, and (iii) sold You the Product new and in its original packaging.

“**Formal Warranty Claim**” means a claim made in accordance with the section “Formal Warranty Claims” herein.

“**Product**” means a Product (i) that is listed in the Specifications Table below, (ii) that You bought from an Authorized Dealer new and in its original packaging, and (iii) whose serial number, if any, has not been removed, altered, or defaced.

“**Product Defect**” means a defect, malfunction, non-conformance to this Limited Warranty, or other inadequacy of the Product that existed at the time when You received the Product from an Authorized Dealer and that causes a failure of the Product to perform in accordance with Monster’s documentation accompanying the Product, unless such failure has been caused completely or partly by (a) any use other than Adequate Use, (b) transportation, neglect, negligence misuse or abuse by anyone other than Monster’s employees; (c) alteration, tampering, modification, or installation of the product by anyone other than a Monster employee; (d) accident (other than a malfunction that is caused by a Product Defect), including power surges; (e) maintenance or service of the Product by anyone other than a Monster employee; (f) exposure of the Product to heat, bright light, sun, liquids, sand or other contaminants; or (g) acts outside the control of Monster, including without limitation acts of God, fire, storms, earthquake or flood.

“**Warranty Period**” means the time period during which Monster must have received Your Formal Warranty Claim. The different Warranty Periods related to Product Defects are defined in the Specifications Table below. The Warranty Period commences on the date when You purchased or received (whichever occurs later) the Product from an Authorized Dealer as evidenced by the Authorized Dealer’s invoice, sales receipt or packing slip. If You do not have written proof of the date of purchase or receipt, then the Warranty Period commences

three (3) months after the date when the Product left Monster's factory as evidenced by Monster's records. The Warranty Period ends after the time defined in the Specifications Table has expired or after You have transferred ownership of the Product, whichever occurs earlier. Also, You must call Monster and obtain a Return Authorization Number (as described under "How to Make a Claim") within two (2) months after You discover a Product Defect (or should have discovered it, if such Product Defect was obvious).

"You" means the first individual person that purchased the Product in its original packaging from an Authorized Dealer. This Limited Warranty does not apply to persons or entities that bought the Product (i) in used or unpackaged form, (ii) for resale, lease or other commercial use, or (iii) from someone other than an Authorized Dealer.

#### **SCOPE OF THIS LIMITED WARRANTY**

**PRODUCTS.** If a Product contained a Product Defect when You bought it from an Authorized Dealer and Monster receives a Formal Warranty Claim from You within two (2) months after You discover such Product Defect (or should have discovered it, if such Product Defect was obvious) and before the end of the Warranty Period for Product Defects applicable to the affected Product, then Monster will provide You with one of the following remedies: Monster will (1) repair or, at Monster's sole discretion, replace the Product, or (2) refund to You the purchase price You paid to the Authorized Dealer for the affected Product if repair or replacement is not commercially practicable or cannot be timely made. NOTE: MONSTER DOES NOT ASSUME ANY LIABILITY FOR ANY INCIDENTAL, CONSEQUENTIAL OR INDIRECT DAMAGES UNDER THIS LIMITED WARRANTY. SOME STATES DO NOT ALLOW THE EXCLUSION OR LIMITATION OF INCIDENTAL OR CONSEQUENTIAL DAMAGES, SO THE ABOVE LIMITATION OR EXCLUSION MAY NOT APPLY TO YOU.

#### **GENERAL PROVISIONS**

**CHOICE OF LAW/JURISDICTION.** This Limited Warranty and any disputes arising out of or in connection with this Limited Warranty ("Disputes") shall be governed by the laws of the State of California, USA, excluding conflicts of law principles and excluding the Convention for the International Sale of Goods. The courts located in the State of California, USA shall have exclusive jurisdiction over any Disputes.

**OTHER RIGHTS.** THIS LIMITED WARRANTY GIVES YOU SPECIFIC LEGAL RIGHTS, AND YOU MAY ALSO HAVE OTHER RIGHTS, WHICH VARY FROM STATE TO STATE. THIS LIMITED WARRANTY EXTENDS ONLY TO YOU AND CANNOT BE TRANSFERRED OR ASSIGNED. If any provision of this Limited Warranty is unlawful, void or unenforceable, that provision shall be deemed severable and shall not affect any remaining provisions. In case of any inconsistency between the English and other versions of this Limited Warranty, the English version shall prevail.

**Registration.** Please register Your Product at [www.monstercable.com](http://www.monstercable.com). Failure to register will not diminish Your warranty rights.

#### **SPECIFICATIONS TABLE**

PRODUCT MODEL NUMBER	WARRANTY PERIOD FOR PRODUCT
MPC FX IC-FD6	Two (2) Years

#### **FORMAL WARRANTY CLAIM**

**HOW TO MAKE A CLAIM.** (1) Call, or write to, Monster within two (2) months after You discover a Product Defect (or should have discovered it, if such Product Defect was obvious); (2) Give a detailed explanation of how the damage occurred; (3) Obtain a Return Authorization Number; (4) Upon receipt of a claim form (which may be sent to You after You filed Your Formal Warranty Claim), fill out the claim form entirely; (5) Return the Products, shipping prepaid by You (to be refunded if You are entitled to a remedy under the Scope of this Limited Warranty), to Monster for verification of damage, along with a copy of Your original sales receipts and proof of purchase (UPC label or packing slip) for such Products, the completed claim form, and printed Return Authorization Number on the outside of the return package (the claim form will include instructions for return).

**TOLL-FREE TELEPHONE NUMBERS.** United States: 1-877-800-8989 (toll-free), or 1-415-840-2000.

**ADDRESS:** Monster Cable Products, Inc. 455 Valley Drive, Brisbane, CA 94005 USA

**FURTHER PROCEEDINGS.** Monster will determine whether a Product Defect existed. Monster may, at its discretion, direct You to obtain a repair estimate at a service center. If a repair estimate is required, You will be instructed on how to properly submit the estimate and the resulting invoice to Monster for payment. Any fees for repairs may be negotiated by Monster.

**TIMING.** If You bring a Formal Warranty Claim and fully comply with all terms and conditions of this Limited Warranty, Monster will use its best efforts to provide You with a remedy within thirty (30) days after receipt of Your Formal Warranty Claim (if You reside in the United States - forty-five (45) days if You reside elsewhere), unless obstacles outside Monster's control delay the process.

Ver.12/14/2004 – US ©2005 Monster Cable Products, Inc.

**NOTES**

**NOTES**

# **MONSTER**

**PERFORMANCE CAR™**

455 Valley Drive  
Brisbane, CA 94005 USA

Visit us on the Web at  
**MonsterPerformanceCar.com**

Monster iCruze is designed and engineered  
in the USA, and manufactured to Monster  
quality specifications in China.

© Copyright 2005 Monster Cable Products, Inc.  
455 Valley Drive, Brisbane CA 94005 USA

Monster, Monster Performance Car, Factory•Linx, QuickCruze, the Monster Performance Car logo and the product design are the products of registered or unregistered trademarks of Monster Cable Products, Inc. or its subsidiaries in the U.S. and abroad. iCruze and Soundgate are registered and unregistered trademarks of The Putnum Group, Inc. iPod, Apple are trademarks of Apple Computer, Inc. Alpine is a registered trademark of Alpine Electronics, Inc. Jaguar is a trademark of Jaguar Cars Limited. Images and illustrations shown may vary from actual product. Specifications subject to change without notice.